

# Innovations

Spring–Summer 2026



**Special offer**  
**torque tools**  
Starting on page 26

# The Zyklop Comfort ratchet

## Your hands will love its plastic sleeve!



### 8010 A Zyklop Comfort ratchet, with reversing lever, with 1/4" drive



- Extremely slim design with a soft, ergonomic grip zone for easy work even in very confined spaces
- Fine toothing with 80 teeth for a short return angle of only 4.5°
- Pleasant feel thanks to the plastic sleeve
- Plastic sleeve protects surfaces from damage



	□	⌀
	mm	
0500560001	1/4"	144,0

## For small spaces



With its extremely slim design, the Zyklop Comfort ratchet allows easy working even in very confined spaces.

## Plastic coated

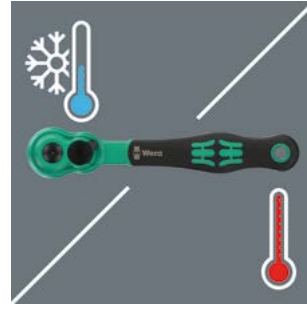

The plastic sleeve makes working comfortable and safe even at extremely low or high temperatures.

### 8100 SA 13 Zyklop Comfort ratchet set, reversing lever, 1/4" drive, metric



- 15-piece Zyklop Comfort ratchet set; 1/4"; sockets in metric sizes
- Compact textile box with twist-to-unlock system: the tools are securely stored, yet easy to remove
- Textile box made of robust material, protects surfaces from damage, can be docked onto the Wera 2go system

### 8100 SA 14 Zyklop Comfort ratchet set, reversing lever, 1/4" drive, metric



- 28-piece Zyklop Comfort ratchet set; 1/4"; sockets in metric sizes
- One bit holder for 1/4" bits; 15 bits for universal use (Phillips, Pozidriv, TORX®, hexagonal socket)
- Compact textile box with twist-to-unlock system: the tools are securely stored, yet easy to remove
- Textile box made of robust material, protects surfaces from damage, can be docked onto the Wera 2go system

05004022001	
□	8010 A 1x 1/4"x144,0
●	8790 HMA 1x 4,0x23,0; 1x 4,5x23,0; 1x 5,0x23,0; 1x 6,0x23,0; 1x 7,0x23,0; 1x 8,0x23,0; 1x 9,0x23,0; 1x 10,0x23,0; 1x 11,0x23,0; 1x 12,0x23,0; 1x 13,0x23,0; 1x 14,0x23,0
●	8794 LA 1x 1/4"x150,0
●	8794 A 1x 1/4"x56,0
	Hook and Loop Fastener Strip 120 1x 50,0x120,0

05005541001	
□	8010 A 1x 1/4"x144,0
●	8790 HMA 1x 5,0x23,0; 1x 5,5x23,0; 1x 6,0x23,0; 1x 7,0x23,0; 1x 8,0x23,0; 1x 10,0x23,0; 1x 11,0x23,0; 1x 12,0x23,0; 1x 13,0x23,0
●	8794 LA 1x 1/4"x150,0
●	8794 A 1x 1/4"x56,0
●	8784 A1 1x 1/4"x1/4"x37,0
+	851/4 TZ 1x PH 1x50; 1x PH 2x50; 1x PH 3x50
+	855/4 TZ 1x PZ 2x50; 1x PZ 3x50
+	867/4 Z 1x TX 10x50; 1x TX 15x50; 1x TX 20x50; 1x TX 25x50; 1x TX 27x50; 1x TX 30x50
○	840/4 Z 1x 3,0x50; 1x 4,0x50; 1x 5,0x50; 1x 6,0x50 <sup>1)</sup>
	Hook and Loop Fastener Strip 120 1x 50,0x120,0

<sup>1)</sup> Hexagonal blade



## 8100 SA 15 Zyklop Comfort ratchet set, reversing lever, 1/4" drive, imperial



- 28-piece Zyklop Comfort ratchet set; 1/4"; sockets in imperial sizes
- Compact textile box with twist-to-unlock system: the tools are securely stored, yet easy to remove
- Textile box made of robust material, protects surfaces from damage, can be docked onto the Wera 2go system

05005542001		
○	8010 A	1x 1/4"x144,0
●	8790 HMA	1x 3/16"x23,0; 1x 7/32"x23,0; 1x 1/4"x23,0; 1x 9/32"x23,0; 1x 5/16"x23,0; 1x 11/32"x23,0; 1x 3/8"x23,0; 1x 7/16"x23,0; 1x 1/2"x23,0
○	8794 LA	1x 1/4"x150,0
○	8794 A	1x 1/4"x56,0
●	8784 A1	1x 1/4"x1/4"x37,0
+	851/4 TZ	1x PH 1x50; 1x PH 2x50; 1x PH 3x50
+	867/4 Z TORX®	1x TX 10x50; 1x TX 15x50; 1x TX 20x50; 1x TX 25x50; 1x TX 27x50; 1x TX 30x50
○	840/4 Z	1x 5/32"x50; 1x 3/16"x50; 1x 7/32"x50; 1x 1/4"x50
○	868/4	1x # 1x50; 1x # 2x50
	Hook and Loop Fastener Strip 120	1x 50,0x120,0

### Easy removal and secure storage

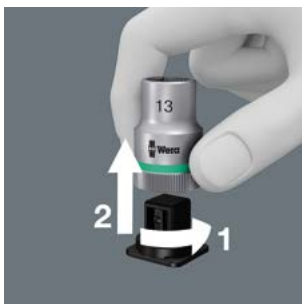

The twist-to-unlock mechanism ensures easy access of the sockets, while also holding them securely.

### Easy removal of the ratchet



Thanks to the twist-to-unlock system, the ratchet can be easily removed (8100 SA 13, 8100 SA 14, 8100 SA 15).



### Fine-tooth design

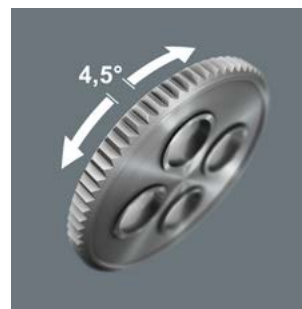

With its fine toothing with 80 teeth, the Zyklop Comfort ratchet allows a short return angle of only 4.5°.



### Ball lock



The ball lock ensures sockets and accessories fit securely, providing increased safety during operation. A short press on the release button allows the tool to be changed quickly.



### The fast-rotating sleeve



The fast-rotating sleeve on the Zyklop extensions effectively accelerates the turning of screws and bolts.

# The Zyklop VDE ratchet

## Twice as safe.





### 8007 A VDE Zyklop ratchet, insulated, with reversing lever, with 1/4" drive



- Insulated and 100% individually tested Zyklop ratchet for safe working up to 1,000 volts
- Fine toothing with 80 teeth for a short return angle of only 4.5°
- Extremely slim design with a soft, ergonomic grip zone for easy work even in very confined spaces
- Safe socket lock via push button, convenient direction change thanks to the reversing lever
- Plastic coating protects surfaces from damage



		8" mm
05004866001	1/4"	144,0

## For electrical building technology



The 1/4" Zyklop VDE ratchet is especially suitable for all couplings in electrical building installations.



**Individually tested**



Safe working at voltages up to 1,000 V is guaranteed as Zyklop tools for electricians are individually tested at 10,000 V as per IEC 60900.

## For small spaces



The extremely slim design of the Zyklop VDE ratchet makes it easy to work, even in confined spaces.

## Easy removal of the ratchet



Thanks to the twist-to-unlock system, the ratchet can be easily removed.

## Ball lock



The ball lock ensures sockets and accessories fit securely, providing increased safety during operation. A short press on the release button allows the tool to be changed quickly.

## 8100 SA VDE 1 Zyklop ratchet set, insulated, reversing lever, 1/4" drive, metric



- 22-piece 1/4" ratchet set; VDE-insulated
- One Zyklop ratchet, 10 sockets, 5 bit sockets with holding function for TORX® screws, 4 bit sockets with holding function for hexagonal socket screws, one extension (150 mm)
- Compact textile box with twist-to-unlock system: the tools are securely stored, yet easy to remove
- Textile box made of robust material, protects surfaces from damage, can be docked onto the Wera 2go system

05004967001		
□	8007 A VDE	1x 1/4"x144,0
●●	8790 A VDE	1x 4,5x41,0; 1x 5,0x41,0; 1x 5,5x41,0; 1x 6,0x41,0; 1x 7,0x41,0; 1x 8,0x41,0; 1x 10,0x41,0; 1x 11,0x41,0; 1x 12,0x41,0; 1x 13,0x41,0; 1x 14,0x41,0
⊗●	8767 A VDE HF	1x TX 10x46,0; 1x TX 15x46,0; 1x TX 20x46,0; 1x TX 25x46,0; 1x TX 30x46,0
●●	8740 A VDE HF	1x 3,0x46,0; 1x 4,0x46,0; 1x 5,0x46,0; 1x 6,0x46,0
□●	8794 LA VDE	1x 1/4"x150,0
	Hook and Loop Fastener Strip 120	1x 50,0x120,0

### 781 A/B VDE connector, insulated, 1/4"



- Connector from 1/4" square head socket to 3/8" external square head
- Individually tested tools as per IEC 60900 at 10,000 V for safe working up to 1,000 volt
- Increased safety thanks to 2-component insulation with a yellow insulation core under an outer red insulation layer
- Plastic coating protects surfaces from damage

	Art.No.				
05024690001	781 A/B VDE	3/8"	56	2 25/32"	1/4"

### 781 B/A VDE connector, insulated, 3/8"



- Connector from 3/8" square head socket to 1/4" external square head

	Art.No.				
05024692001	781 B/A	1/4"	66	2 19/32"	3/8"

### 8794 LA Zyklop VDE extension, insulated, long, 1/4"



- 1/4" VDE Zyklop extension
- Long design (150 mm)
- Individually tested tools as per IEC 60900 at 10,000 V
- Increased safety thanks to 2-component insulation with a yellow insulation core under an outer red insulation layer
- Plastic sleeve protects surfaces from damage

			mm
05003301001	1/4"	150,0	

#### Increased safety



The Zyklop sockets and extensions for electricians offer increased safety thanks to their 2-component insulation with a yellow insulation core under an outer red insulation layer.

#### Insulated connectors from square head socket to external square head



The insulated connectors adapt from square head socket to external square head: 781 A/B from 1/4" square head socket to 3/8" external square head and 781 B/A from 3/8" square head socket to 1/4" external square head.

# Joker 6006 Self-setting double open-end spanner

Double the possibilities with only one hand.



## The screwdriving workshop "for the pocket"



With its continuous and parallel jaws, the self-setting 6006 Joker S/L double open-end spanner replaces the most used metric and imperial single wrench sizes.

## Joker 6006: low return angle

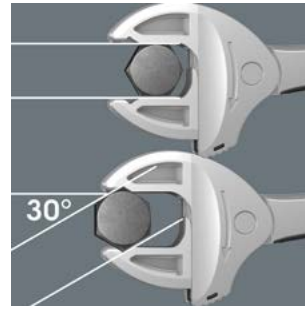

Thanks to the corner-width rectangular prisms in both jaws of the double spanner, a return angle of only 30° can be achieved.



## Joker 6006: ratchet mechanism for quick working



The ratchet functionality in both jaws of the double spanner ensures fast and consistent screwdriving without removing the tool.



## Joker 6006: gentle to the screw

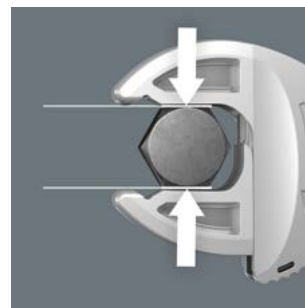

The parallel, smooth jaws of the Joker 6006 double spanner offer a seating stress and can thus prevent the nut or screw head from rounding, which can occur when power is transmitted over corners.

## 6006 Joker S/L Self-setting double open-end spanner



- The screwdriving workshop "for the pocket"
- The most common wrench sizes in one tool
- Self-setting double open-end spanner; return angle of only 30° when using the corner-width rectangular prisms in the jaw
- For hexagon screw heads and bolts with sizes 10-13 and 16-19 (metric) or 7/16"-1/2" and 5/8"-3/4" (imperial) and all intermediate sizes
- Automatically and continuously gripping hexagon screws and bolts
- Lever mechanism upon gripping prevents slipping and damage
- With mechanical ratchet functionality for fast and consistent screwdriving without removing the spanner

	Metric			Imperial			
	mm	mm	mm	mm	mm	mm	
05020332001	10,0; 11,0; 12,0; 13,0	7/16"; 1/2"	16,0; 17,0; 18,0; 19,0	5/8"; 11/16"; 3/4"	10	14,0	208,6

# Joker 6004 self-setting, adjustable spanner

## Self-setting. Gripping. Ratcheting.



### 6004 Joker 2 set 1 Self-setting spanner set



- 2 self-setting spanners with ratchet functionality
- For hexagon screw heads and bolts with wrench sizes 19.0; 20.0; 21.0; 22.0; 24.0; 27.0; 30.0; 32.0 (metric)
- For hexagon screw heads and bolts with wrench sizes 3/4"; 25/32"; 13/16"; 7/8"; 15/16"; 31/32"; 1"; 1 1/16"; 1 1/8"; 1 3/16"; 1 1/4" (imperial)



05343820001	
6004 Joker XL	1x 19,0; 20,0; 21,0; 22,0; 24,0 (3/4"; 25/32"; 13/16"; 7/8"; 15/16")x256
6004 Joker XXL	1x 24,0; 27,0; 30,0; 32,0 (15/16"; 31/32"; 1"; 1 1/16"; 1 1/8"; 1 3/16"; 1 1/4")x322



### Joker 6004: ratchet mechanism for quick working



The ratchet feature in the jaw ensures fast and consistent screwdriving without removing the tool.



### Joker 6004: gentle to the screw

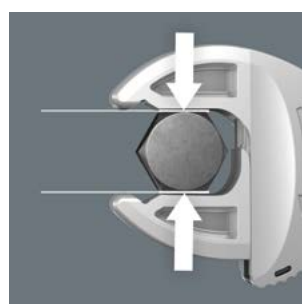

The parallel smooth jaws of the Joker 6004 allow surface pressure and can thus prevent rounding of the bolt or screw head, which can occur during power transmission via the corners.

## 6004 Joker 6 Set 1 Self-setting spanner set



- 6 self-setting spanners with ratchet functionality
- For hexagon screw heads and bolts with sizes 7-32 or 1/4"-1 1/4" (imperial) and all intermediate sizes
- Automatically and continuously gripping hexagon screws and bolts
- With mechanical ratchet functionality for fast and consistent screwdriving without removing the spanner
- Return angle of only 30° when using the corner-width rectangular prisms in the jaw
- Textile robust roll pouch

●	
05020111001	
6004 Joker XS	1x 7,0; 8,0; 9,0; 10,0 (1/4"; 5/16"; 3/8")x117
6004 Joker S	1x 10,0; 11,0; 12,0; 13,0 (7/16"; 1/2")x154
6004 Joker M	1x 13,0; 14,0; 15,0; 16,0 (1/2"; 17/32"; 9/16"; 19/32"; 5/8") x188
6004 Joker L	1x 16,0; 17,0; 18,0; 19,0 (5/8"; 11/16"; 3/4")x224
6004 Joker XL	1x 19,0; 20,0; 21,0; 22,0; 24,0 (3/4"; 25/32"; 13/16"; 7/8"; 15/16")x256
6004 Joker XXL	1x 24,0; 27,0; 30,0; 32,0 (15/16"; 31/32"; 1"; 1 1/16"; 1 1/8"; 1 3/16"; 1 1/4")x322

### Joker 6004: low return angle

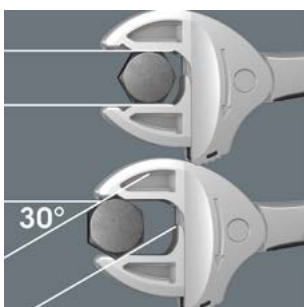

The corner-width rectangular prisms in the jaw allow a return angle of only 30°.



### Joker 6004: automatically and continuously self-setting



With its automatically and continuously gripping parallel jaws the Joker spanner 6004 covers all dimensions in the respective field of application. The tool automatically finds the required size when placed on the bolt or screw, no setting required.

# Joker 6007 Ratcheting combination spanner

## Size matters.



### 6007 Joker SB Ring ratchet spanner, long design



- Brilliant combination of jaw end and ratchet mechanism at the ring end in a long design
- Practical holding function thanks to the metal plate in the jaw
- Limit stop prevents any slipping
- The double-hex geometry reduces the risk of slipping
- Return angle of only 30°
- With Take it easy tool finder: colour coding by size

	mm	mm	mm	mm	mm	mm
05020355001 <sup>1)</sup>	11	220	26	7	23	7,5
05020356001 <sup>1)</sup>	12	245	29	8	26	8,6
05020357001 <sup>1)</sup>	14	265	34	8,5	29	9,2
05020358001 <sup>1)</sup>	15	265	34	8,5	29	9,2
05020359001 <sup>1)</sup>	16	304,5	39	9	33,5	10,5
05020360001 <sup>1)</sup>	18	334	43	10	36	11

<sup>1)</sup> Available from May 2026

### 6007 Joker Ratcheting combination spanner SB, long design, imperial



- Imperial sizes

	mm	mm	mm	mm	mm	mm
05020361001 <sup>1)</sup>	5/16"	180	21	6	18	7
05020362001 <sup>1)</sup>	3/8"	209	24,2	6,3	21	7,2
05020363001 <sup>1)</sup>	7/16"	220	26	7	23	7,5
05020364001 <sup>1)</sup>	1/2"	245	29,4	8	26	8,6
05020365001 <sup>1)</sup>	9/16"	265	34	8,5	29	9,2
05020366001 <sup>1)</sup>	5/8"	304,5	39	9	33,5	10,5
05020367001 <sup>1)</sup>	11/16"	334	43	10	36	11
05020368001 <sup>1)</sup>	3/4"	334	43	10	36	11

<sup>1)</sup> Available from May 2026

## 6007 Joker 11 Set 1 Ratcheting combination spanner set



- 11-piece set
- Metric
- 2 loops to hang up the roll pouch when open or closed

05020382001	
6007 Joker	1x 8x180; 1x 10x209; 1x 11x220; 1x 12x245; 1x 13x245; 1x 14x265; 1x 15x265; 1x 16x304,5; 1x 17x304,5; 1x 18x334; 1x 19x334

<sup>†</sup> Available from May 2026

## 6007 Joker Imperial 8 Set 1 Ratcheting combination spanner set, imperial



- 8-piece set
- Imperial sizes
- 2 loops to hang up the roll pouch when open or closed

05020385001	
6007 Joker	1x 5/16"x180; 1x 3/8"x209; 1x 7/16"x220; 1x 1/2"x245; 1x 9/16"x265; 1x 5/8"x304,5; 1x 11/16"x334; 1x 3/4"x334

<sup>†</sup> Available from May 2026

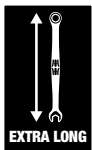

### Long design



The long design of the spanner improves accessibility at low-lying couplings.



### High power transmission

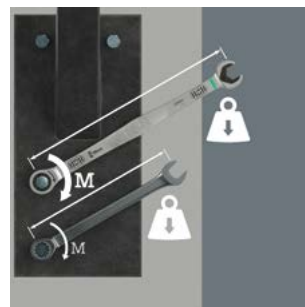

The long lever of the spanner allows for higher power transmission. Brilliant combination of jaw end and ratchet mechanism at the ring end, which can withstand even heavy loads.



### Return angle of only 30° in the open end



The double hexagon geometry of the jaw end reduces the return angle of the Joker 6007 to 30°. The Joker 6007 has a straight jaw – awkward turning and repositioning is a thing of the past.



### With holding function for hexagonal screws and bolts



The Joker's holding function means that nuts and bolts can be held in the jaw and easily positioned where they are needed. Fastening on to the thread can then be done quickly and safely, thanks to the innovative special stop-plate which holds the fastener. No more time-wasting searches

for dropped nuts and bolts! After applying and positioning the nut or bolt, fastening can begin immediately – no additional tools required.

**9998 X-Power actuation tool for insert tools,  
9x12 mm**



- Plug connection for mounting insert tools
- With 9x12 mm mounting for exchangeable insert tools
- The actuation tool is suitable for tightening and loosening screw connections, using insert tools
- No torque function!
- Solid made from alloyed tool steel; matte-chromed

	mm mm
05003200001	9x12 400

**9999 X-Power actuation tool for insert tools,  
14x18 mm**



- With 14x18 mm mounting for exchangeable insert tools

	mm mm
05003201001	14x18 600

**Many combinations possible**

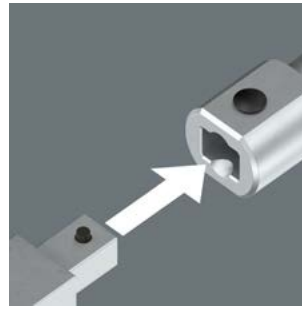

The actuation tools are suitable for mounting insert tools with square head drive, and can thus be used in a variety of operations.

**Tightening and loosening without torque**



With an insert tool, the actuation tools are suitable for tightening and loosening stuck screw connections – without torque.

**Solid made of alloyed tool steel**



The matte-chromed solid used, made of alloyed special purpose steel, offers high form stability, and is resistant to deformation due to its increased strength.

**Ergonomic Kraftform handle**



The multi-component Kraftform handle ensures ergonomic, fatigue-free work without injuries.

**X-Power**

**Powerful loosening of screw connections without torque function.**



## Click-Torque Lock C 3 car wheel change set 1

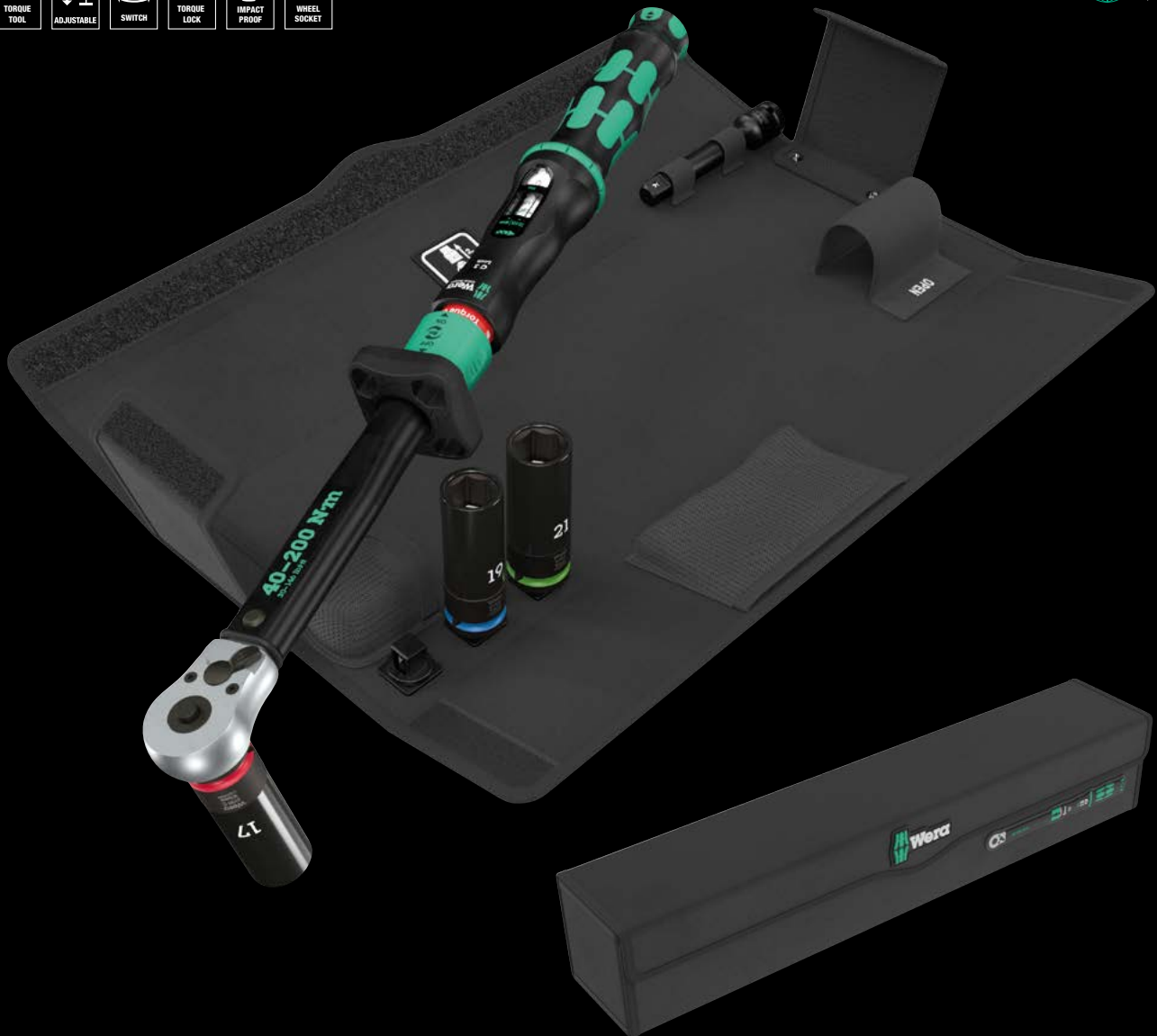

- Tool set for the car wheel change
- Measuring range: 40-200 Nm; precision  $\pm 3\%$  as per DIN EN ISO 6789-1:2017-07
- Torque Lock function: The torque function can be deactivated so that the tool can also be used for loosening
- Extra click: audible and tactile torque setting
- 3x 8790 C Wheel Impaktor sockets,  $\frac{1}{2}$ " , sizes 17.0; 19.0; 21.0
- The inner plastic insert of the sockets helps protect the surface of the wheel screws
- With Take it easy tool finder: colour coding by size
- The textile box can be fully unfolded; easy access to the tools inside

		
05075790001		
	Click-Torque Lock C 3	1x $\frac{1}{2}$ " , 40-200 Nm
●●	8790 C Wheel Impaktor	1x 17,0x85,0x30,0; 1x 19,0x85,0x30,0; 1x 21,0x85,0x32,0
●○	8894 SC	1x $\frac{1}{2}$ "x125,0
	7762	1x 55,0x55,0x21,5

# Car wheel change set with Click-Torque Lock: controlled tightening and loosening with only one tool



## Click-Torque Lock car wheel change set



The professional solution for the car wheel change. Precise and secure tightening of wheel nuts using the Click-Torque Lock C 3 torque wrench. The Torque Lock function also allows screws and bolts to be loosened without torque. Three robust sockets with rotating plastic sleeve and protection for wheel screws offer the transmission of high forces without loading the edges of the bolt. Low-lying wheel screws can also be reached with the extension (125 mm long).



## Click-Torque Lock: controlled tightening and loosening



With this torque wrench, not only controlled tightening of screws and bolts is possible. The brilliant Torque Lock function also allows for **loosening** screws and bolts.

## Easy and safe



Easy setting and saving of the desired torque value; easy to read on main and fine scales.

## Smooth plastic sleeve



The rotating plastic sleeve allows for higher control during screwdriving. In addition, the surface of the rim is protected. The plastic sleeves are interchangeable.

# Tool Rebel roller cabinets





05150131001 1x 9701

- XXL roller cabinet in the exclusive Tool Rebel design
- Width x height x depth: 1133 x 1020 x 518 mm
- Extremely robust thanks to a double-walled design
- Large storage and work surface in stainless steel; completely sealed to protect the inside of the cabinet, e.g. from leaking liquids
- With 7 drawers (5 flat, 2 high) – of which 2 flat drawers are equipped with foam inserts and tools (e.g. with Zyklop Speed ratchets and accessories (1/4" and 1/2"), Joker ratcheting combination wrenches and combination wrenches, Kraffform screwdrivers, L-keys, Kraffform Kompakt 60 and Tool-Check PLUS)
- Dimensions flat drawers (width x height x depth): 870 x 81 x 398 mm
- Dimensions high drawers (width x height x depth): 870 x 166 x 398 mm
- 100 % drawer pull-out with ball bearing telescopic slides, self-closing
- Minimum risk of tilting over thanks to the drawer stop – only one drawer can be opened, no simultaneous pull-out of multiple drawers
- Both sides with square head boring
- High-quality, durable foam inserts without chemical vapours

**Includes the following foam inserts:**



9710 Foam insert screwdriver set 1  
05150101001



9720 Foam insert 8000 A Zyklop 1/4" ratchet set 1  
05150110001



9722 Foam insert 8000 C Zyklop 1/2" ratchet set 1  
05150112001



9730 Foam insert 6000 Joker set 1  
05150120001



9731 Foam insert 6003 Joker set 1  
05150121001



9740 Foam insert L-key set 1  
05150140001

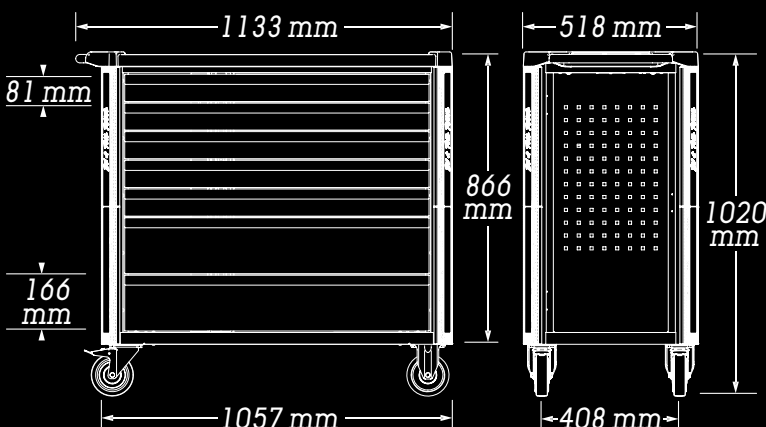

9750 Foam insert Kraffform Kompakt and Tool-Check PLUS set 1  
05150150001



05150132001 | 1x 9702

- With 7 drawers (5 flat, 2 high) – of which 2 flat drawers are equipped with foam inserts and tools (e.g. with Zyklop Speed ratchets and accessories (1/4" and 3/8"), Joker ratcheting combination wrenches and combination wrenches, Kraftform screwdrivers, L-keys, Kraftform Kompakt 60 and Tool-Check PLUS)

**Includes the following foam inserts:**



9710 Foam insert screwdriver set 1  
05150101001



9720 Foam insert 8000 A Zyklop 1/4" ratchet set 1  
05150110001



9721 Foam insert 8000 B Zyklop 3/8" ratchet set 1  
05150111001



9723 Foam insert Zyklop B 3/8" bit socket set 1  
05150113001

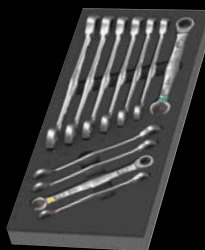

9730 Foam insert 6000 Joker set 1  
05150120001



9731 Foam insert 6003 Joker set 1  
05150121001



9740 Foam insert L-key set 1  
05150140001



9750 Foam insert Kraftform Kompakt and Tool-Check PLUS set 1  
05150150001

**High loads**



The dynamic load of the roller cabinets is 750 kg, the static load is 1,000 kg and the drawer load is 40 kg.

**Robust design for hard work in the workshop**



The double-walled design and the completely welded construction make the Tool Rebel roller cabinet extremely robust. The optimized yielding edge protection on all four corners ensures reliable impact protection thanks to an internal cushioning action.

**Heavy-duty gear**



The Tool Rebel roller cabinet has large, robust wheels with precision ball bearings and double ball rims in the spindle carrier. Even under high dynamic loads, the roller cabinet is easy to move.



**Includes the following foam inserts:**

05150135001 1x 9705

- Exclusive roller cabinet in the Tool Rebel design
- Width x height x depth: 785 x 1020 x 518 mm
- Extremely robust thanks to a double-walled design
- Storage and work surface in stainless steel; completely sealed to protect the inside of the cabinet, e.g. from leaking liquids
- With 7 drawers (5 flat, 2 high) – of which 3 flat drawers are equipped with foam inserts and tools (e.g. with Zyklop Speed ratchets and accessories (1/4" and 1/2"), Joker combination wrenches, Kraftform screwdrivers, L-keys, Kraftform Kompakt 60 and Tool-Check PLUS)
- Dimensions flat drawers (width x height x depth): 522 x 81 x 398 mm
- Dimensions high drawers (width x height x depth): 522 x 166 x 398 mm
- 100 % drawer pull-out with ball bearing telescopic slides, self-closing
- Minimum risk of tilting over thanks to the drawer stop – only one drawer can be opened, no simultaneous pull-out of multiple drawers



9710 Foam insert screwdriver set 1  
05150101001



9720 Foam insert 8000 A Zyklop 1/4" ratchet set 1  
05150110001



9722 Foam insert 8000 C Zyklop 1/2" ratchet set 1  
05150112001



9731 Foam insert 6003 Joker set 1  
05150121001



9740 Foam insert L-key set 1  
05150140001



9750 Foam insert Kraftform Kompakt and Tool-Check PLUS set 1  
05150150001

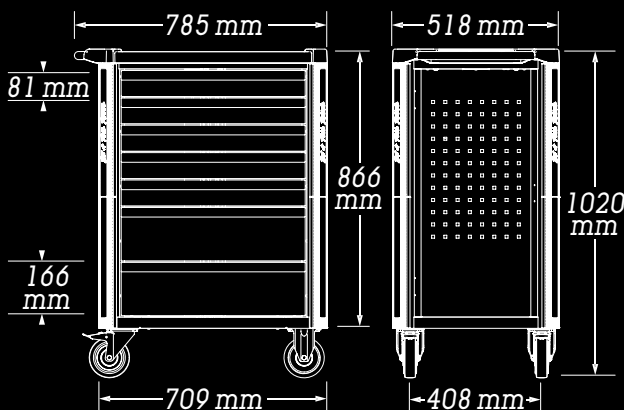



05150136001 | 1x 9706

- With 7 drawers (5 flat, 2 high) – of which 3 flat drawers are equipped with foam inserts and tools (e.g. with Zyklop Speed ratchets and accessories (3/8" and 1/2"), Joker combination wrenches, Kraffform screwdrivers, L-keys, Kraffform Kompakt 60 and Tool-Check PLUS)

### Includes the following foam inserts:



9710 Foam insert  
screwdriver set 1  
05150101001



9720 Foam insert 8000 A  
Zyklop 1/4" ratchet set 1  
05150110001



9721 Foam insert  
8000 B Zyklop 3/8" ratchet set 1  
05150111001



9723 Foam insert Zyklop B 3/8"  
bit socket set 1  
05150113001



9731 Foam insert  
6003 Joker set 1  
05150121001



9740 Foam insert  
L-key set 1  
05150140001



9750 Foam insert Kraffform Kompakt  
and Tool-Check PLUS set 1  
05150150001

### High loads



The dynamic load of the roller cabinets is 540 kg, the static load is 1,000 kg and the drawer load is 30 kg.

### Storage and work surface with lots of advantages



The storage and work surface is made of stainless steel and, being also completely sealed, the inside of the trolley is protected from leaking liquids.

### Secure locking, smooth running



The two swivel castors are equipped with a double stop: The locked castor reliably prevents it from rolling away, the locked spindle carrier prevents the castors from turning unintentionally, e.g. on sloped surfaces. The oil- and acid-resistant elastic wheels ensure smooth running. A protective ring prevents the ingress of dirt and threads.

ring prevents the ingress of dirt and threads.

## 9727 Foam insert 8007 A VDE Zyklop VDE ratchet set 1, 1/4"

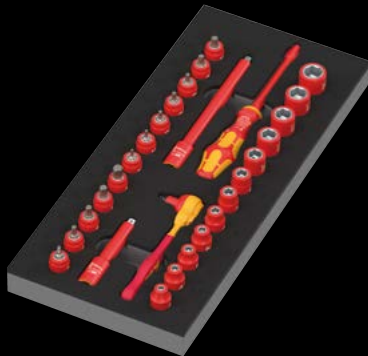

- Durable foam insert, each tool has its own place; two-coloured – missing tools will quickly be noticed; optimal fit for the best possible tool removal from the foam insert
- Width x height x depth: without tools 344 x 30 x 392 mm, with tools 344 x 52 x 392
- Includes one Zyklop VDE ratchet, 12 sockets, 7 bit sockets with holding function for TORX® screws, 5 bit sockets with holding function for hexagonal socket screws, 2 extensions (75 mm and 150 mm long), one handle for Kraftform Kompakt VDE blades, one adapter blade (1/4" external hexagon to 9 mm external hexagon)
- Individually tested tools as per IEC 60900 at 10,000 V for safe working up to 1,000 volt
- Ratchet in extremely slim design; fine toothing with 80 teeth, short return angle of only 4.5° for easy working even in very confined spaces
- Sockets, bit sockets and extensions with increased safety thanks to a 2-component insulation with yellow insulation core under red outer insulation layer
- 817 VDE handle for Kraftform Kompakt interchangeable blades
- One Kraftform Kompakt A VDE 712 i adapter blade (1/4" external hexagon to 9 mm external hexagon) for 1/4" sockets and bit sockets

05150117001	
○	8007 A VDE 1x 1/4"x144,0
●●	8790 A VDE 1x 4,0x41,0; 1x 4,5x41,0; 1x 5,0x41,0; 1x 5,5x41,0; 1x 6,0x41,0; 1x 7,0x41,0; 1x 8,0x41,0; 1x 10,0x41,0; 1x 11,0x41,0; 1x 12,0x41,0; 1x 13,0x41,0; 1x 14,0x41,0
⊕	8767 A VDE 1x TX 10x46,0; 1x TX 15x46,0; 1x TX 20x46,0; HF 1x TX 25x46,0; 1x TX 27x46,0; 1x TX 30x46,0; 1x TX 40x46,0
●●	8740 A VDE 1x 3,0x46,0; 1x 4,0x46,0; 1x 5,0x46,0; HF 1x 6,0x46,0; 1x 8,0x47,0
○●	8794 LA VDE 1x 1/4"x150,0
○●	8794 SA VDE 1x 1/4"x91,0
●	817 VDE 1x 9x98
○●	Kraftform Kompakt A VDE 712 i 1x 1/4"x154
9827	1x 172,0x30,0x392,0

<sup>1)</sup> Attention: The foam insert does not fit in the previous model 05501051001 of the roller cabinet.

## 9728 Foam insert Zyklop B 3/8" Impaktor Deep socket set 1



- Durable foam insert, each tool has its own place; two-coloured – missing tools will quickly be noticed; optimal fit for the best possible tool removal from the foam insert
- Width x height x depth: without tools 172 x 30 x 392 mm, with tools 172 x 47 x 392 mm
- Long 3/8" socket wrench for low-lying couplings in confined spaces und protruding thread rods
- For use with electric or pneumatic wrenches with 3/8" drive
- Hexagon profile allows precise and profile-friendly screwdriving with high power transmission
- With cross hole and ring socket to attach the safety pin and safety ring of machine operated tools
- With Take it easy tool finder: colour coding by size

05150118001	
●●	8790 B Impaktor Deep 1x 8,0x63,0; 1x 10,0x63,0; 1x 11,0x63,0; 1x 12,0x63,0; 1x 13,0x63,0; 1x 14,0x63,0; 1x 15,0x63,0; 1x 16,0x63,0; 1x 17,0x63,0; 1x 18,0x63,0; 1x 19,0x63,0; 1x 21,0x63,0; 1x 22,0x63,0; 1x 24,0x63,0
9828	1x 172,0x30,0x392,0 <sup>1)</sup>

<sup>1)</sup> Attention: The foam insert does not fit in the previous model 05501051001 of the roller cabinet.

## 9735 Foam insert 6007 Joker set 1



- Durable foam insert, each tool has its own place; two-coloured – missing tools will quickly be noticed; optimal fit for the best possible tool removal from the foam insert
- Width x height x depth: without tools 344 x 30 x 392 mm, with tools 344 x 47 x 392 mm
- Brilliant combination of jaw end and ratchet mechanism at the ring end in a long design
- The long lever allows for higher power transmission and better accessibility at low-lying couplings
- Limit stop prevents any slipping
- With practical holding function by a metal plate in the mouth
- Extremely robust ring ratchet
- Take it easy tool finder: colour coding by size and extra laser-engraved size indication

05150125001		
6007 Joker	1x 8x180; 1x 10x209; 1x 11x220 <sup>1)</sup> ; 1x 12x245 <sup>1)</sup> ; 1x 13x245; 1x 14x265 <sup>1)</sup> ; 1x 15x265 <sup>1)</sup> ; 1x 16x304,5 <sup>1)</sup> ; 1x 17x304,5; 1x 18x334 <sup>1)</sup> ; 1x 19x334	
9835	1x 172,0x30,0x392,0	

<sup>1)</sup> Available from May 2026

<sup>2)</sup> Attention: The foam insert does not fit in the previous model 05501051001 of the roller cabinet.

## 9753 Foam insert Kraffform Kompakt maintenance set 1



- Durable foam insert, each tool has its own place; two-coloured – missing tools will quickly be noticed; optimal fit for the best possible tool removal from the foam insert
- Width x height x depth: without tools 344 x 30 x 392 mm, with tools 344 x 41 x 392 mm
- One Kraffform Kompakt VDE 817 bitholding screwdriver and 10 blades; individually tested as per IEC 60900
- 1/4" Zyklop ratchet and accessories (sockets, extension, bit adapter, bits)
- Joker 6002 double spanner with practical holding function by a metal plate in the open end
- Joker 6004 S self-setting spanner for bolts and screws of 10-13 mm (metric) and 7/16"-1/2" (imperial)
- L-keys (sizes 3 and 4) with hose sleeve, with holding function for hexagonal socket screws, the Hex-Plus profile prevents premature rounding of hexagonal socket screws
- 1 KNIPEX Cobra® High-Tech Water Pump Pliers 87 01 250

05150153001		
●	817 VDE	1x 9x98
●	Kraffform Kompakt VDE 60 i Take it easy	1x 0,4x2,5x157
●	Kraffform Kompakt VDE 60 iS Take it easy	1x 0,6x3,5x157
+	Kraffform Kompakt VDE 62 iS Take it easy	1x PH 1x157; 1x PH 2x157
+	Kraffform Kompakt VDE 65 iS Take it easy	1x PZ 1x157; 1x PZ 2x157
+	Kraffform Kompakt VDE 67 i TORX® Take it easy	1x TX 10x157
+	Kraffform Kompakt VDE 67 iS TORX® Take it easy	1x TX 15x157; 1x TX 20x157; 1x TX 25x157
○	8000 A	1x 1/4"x152,0
●●	8790 HMA	1x 5,5x23,0; 1x 6,0x23,0; 1x 7,0x23,0; 1x 8,0x23,0; 1x 10,0x23,0; 1x 11,0x23,0; 1x 12,0x23,0; 1x 13,0x23,0
●○	8794 SA	1x 1/4"x75,0
●●	8784 A1	1x 1/4"x1/4"x37,0
●○	893/4/1 K	1x 1/4"x50
+	851/1 Z	1x PH 1x25; 1x PH 2x25
+	855/1 Z	1x PZ 1x25; 1x PZ 2x25
+	867/1 TORX®	1x TX 10x25; 1x TX 15x25; 1x TX 20x25; 1x TX 25x25
○	840/1 Z	1x 3,0x25; 1x 4,0x25; 1x 5,0x25; 1x 6,0x25
●	800/1 Z	1x 0,6x4,5x25; 1x 0,8x5,5x25; 1x 1,0x5,5x25; 1x 1,2x6,5x25
	6002 Joker Double	1x 17x19x235
	6004 Joker S	1x 10,0; 11,0; 12,0; 13,0x7/16"; 1/2"x154
○	950 SPKL HF Multicolour	1x 3,0x123; 1x 4,0x137
	KNIPEX Cobra® High-Tech Water Pump Pliers 87 01 250	1x 3,0x123; 1x 4,0x137
	9853	1x 344,0x30,0x392,0 <sup>1)</sup>

<sup>1)</sup> Attention: The foam insert does not fit in the previous model 05501051001 of the roller cabinet.

## 9716 Foam insert Kraftform Micro screwdriver set 2



- Durable foam insert, each tool has its own place; two-coloured – missing tools will quickly be noticed; optimal fit for the best possible tool removal from the foam insert
- Width x height x depth: without tools 172 x 30 x 392 mm, with tools 172 x 37 x 392 mm
- Kraftform Micro screwdrivers
- Multi-component Kraftform Micro handle for fast and ergonomic screwdriving
- The Wera Black Point tip offers an exact fit and optimum corrosion protection
- Take it easy tool finder: colour coding according to profile and size

05150107001		
+	2050 PH	1x PH 00x60 <sup>1)</sup> ; 1x PH 0x60 <sup>2)</sup>
+	2067 TORX®	1x TX 5x40; 1x TX 6x40
○	2054	1x 0,9x40; 1x 1,5x60; 1x 2x60
●	2035	1x 0,23x1,5x40; 1x 0,30x1,8x60; 1x 0,40x2,0x60; 1x 0,40x2,5x80; 1x 0,50x3,0x80
	9816	1x 172,0x30,0x392,0

<sup>1)</sup> Optimised for Asian PH screws

<sup>2)</sup> Size 0 modified according to JGIS 0 (Japanese Camera Industrial Standard)

<sup>3)</sup> Attention: The foam insert does not fit in the previous model 05501051001 of the roller cabinet.

## 9760 Foam insert Stainless set 1



- Durable foam insert, each tool has its own place; two-coloured – missing tools will quickly be noticed; optimal fit for the best possible tool removal from the foam insert
- Width x height x depth: without tools 344 x 30 x 392 mm, with tools 344 x 45 x 392 mm
- Tools made of stainless steel to prevent extraneous rust
- Zyklop 8001 A Mini bit ratchet (60 teeth, return angle 6°), drop-forged solid steel design; for 1/4" hex drive bits and with adapter for 1/4" sockets
- Screwdriver with Kraftform Plus handle for comfortable ergonomic screwdriving, avoiding blisters and calluses
- L-keys with holding function for hexagonal socket screws and Hex-Plus profile (prevents rounding of hexagonal socket screws)
- L-keys with holding function for TORX® screws
- Screwdrivers, L-keys and bits with Take it easy tool finder: colour coding and size stamping to find the required tool quickly

05150160001		
1x Bicycle set 9		
●	8001 A	1x 1/4"x87.0
+	3851/1 TS PH	1x PH 2x25
+	3867/1 TS TORX®	1x TX 10x25; 1x TX 25x25
○	3840/1 TS	1x 2.0x25; 1x 2.5x25; 1x 3.0x25; 1x 4.0x25; 1x 5.0x25; 1x 6.0x25 <sup>1)</sup>
1x 3950/9 Hex-Plus Multicolour HF Stainless 1		
○	3950 SPKL Multicolour	1x 1.5x90; 1x 2.0x101; 1x 2.5x112
○	3950 SPKL Multicolour HF	1x 3.0x123; 1x 4.0x137; 1x 5.0x154; 1x 6.0x172; 1x 8.0x195; 1x 10.0x224
1x 3967/9 TX SXL Multicolour HF Stainless 1		
+	3967 SXL HF TORX® Multicolour	1x TX 8x90; 1x TX 9x101; 1x TX 10x112; 1x TX 15x123; 1x TX 20x137; 1x TX 25x154; 1x TX 27x172; 1x TX 30x195; 1x TX 40x224
+	3350 PH	1x PH 1x80; 1x PH 2x100
+	3367	1x TX 20x100; 1x TX 25x100
●	3335	1x 0.5x3.0x80 <sup>2)</sup> ; 1x 0.8x4.0x100
●	3334	1x 1.2x6.5x150
	9860	1x 344,0x30,0x392,0 <sup>3)</sup>

<sup>1)</sup> Without Torsion zone

<sup>2)</sup> Without Lasertip

<sup>3)</sup> Attention: The foam insert does not fit in the previous model 05501051001 of the roller cabinet.

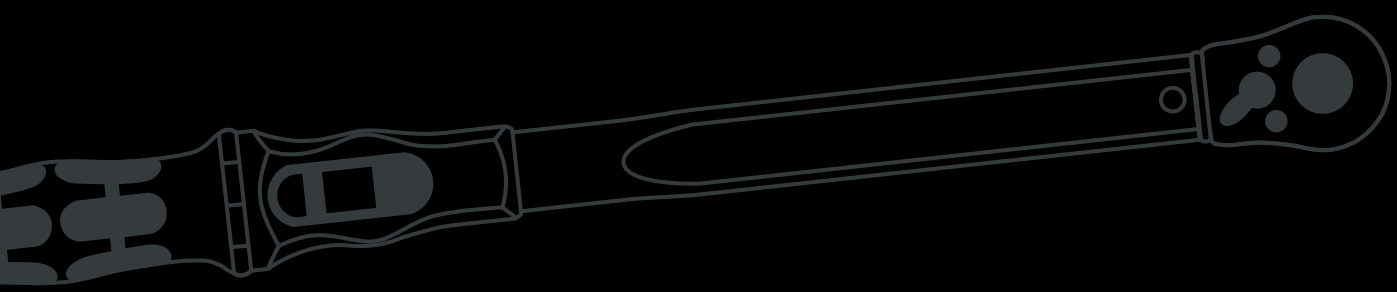

# TORQUE MADE EASY

Special offers  
on selected  
torque tools





# What is torque?

## To put it simply:

The longer a tool (or lever), the less force is required to tighten or loosen a screw. Torque describes precisely this combination of force and distance to the pivot point (e.g. the screw).

## An incorrect torque means:

- Broken or loose screws and damaged threads
- Damaged workpieces
- High additional costs
- Dissatisfied customers

## The challenge:

Making the complex topic of torque as simple as possible during application! Everyone should be able to use torque tools without any problems.

## Wera's solution:

### Torque made easy.

What does "Torque made easy" mean and why is it interesting for YOU?

"Torque made easy" means:  
**Simple operation meets measurable precision!**

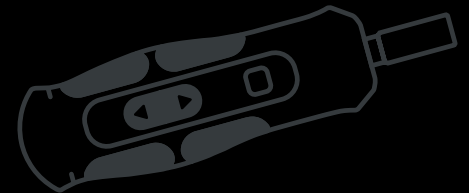

No more "this feels right" inaccurate measurements. If you work with torque, you need measurable precision and safety – day in and day out.

Wera's innovative torque solutions offer exactly what YOU need for YOUR applications. This makes YOUR screwdriving projects easier, safer, and more enjoyable.

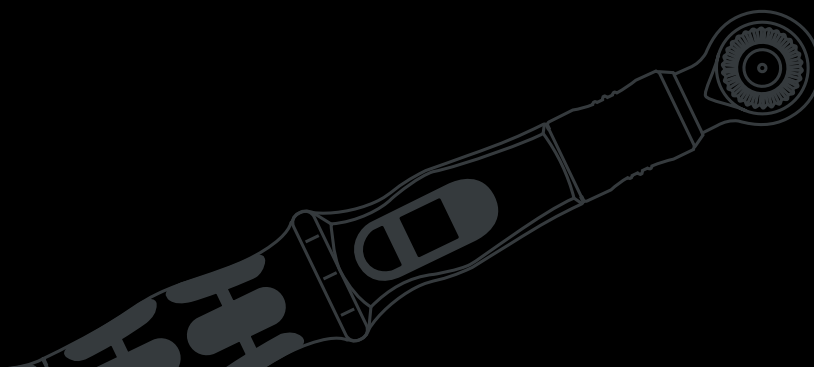

# Wera torque tools at a glance



	Click-Torque	Click-Torque Lock	Safe-Torque	Safe-Torque Speed
<b>Torque range</b>	2,5–1.000 Nm	2,5–200 Nm	2–12 Nm	0,4–6 Nm
<b>Torque can be switched off</b>	No	Yes	Yes	Yes
<b>Prevents overtightening of the torque</b>	No	No	Yes	Yes
<b>Tolerance range</b>	±3 % / ±4 % DIN EN ISO 6789-1:2017-07	±3 % / ±4 % DIN EN ISO 6789-1:2017-07	±10 % No DIN ISO norm	±10 % No DIN ISO norm
<b>Assembly and disassembly with one wrench</b>	No	Yes	Yes	Yes
<b>Special feature</b>	Universal application	Assembly and disassembly with one wrench	Maximum safety thanks to slip-over release mechanism	Quick torque setting via slide switch



Click-Torque Lock



Safe-Torque



Safe-Torque Speed

# Click-Torque Lock

Assembly and disassembly with one wrench.



**Click-Torque Lock A 5 Torque wrench, adjustable, Torque Lock function, reversible ratchet, clockwise torque operation, 2.5-25 Nm**



- Torque wrench – torque function can be switched off/deactivated if required
- When the set value is reached, the torque wrench triggers audibly and tangibly
- Measuring range: 2.5-25 Nm; precision  $\pm 4\%$  as per DIN EN ISO 6789-1:2017-07

	Nm	Nm	lbf. ft.	mm	mm	mm	mm	mm	mm	mm	mm	mm		
05075690001	1/4"	2,5-25	0,10	1-18	299	123	42	26	11,75	11 49/64"	4 59/64"	1 41/64"	1 1/64"	29/64"

**Click-Torque Lock C 3 Torque wrench, adjustable, reversible ratchet, Torque Lock function, 40-200 Nm**



- Torque wrench – torque function can be switched off/deactivated if required
- When the set value is reached, the torque wrench triggers audibly and tangibly
- Measuring range: 40-200 Nm; precision  $\pm 3\%$  as per DIN EN ISO 6789-1:2017-07

	Nm	Nm	lbf. ft.	mm	mm	mm	mm	mm	mm	mm	mm	mm		
05075692001	1/2"	40-200	1,0	30-146	512	140	47	43	18,4	20 5/32"	5 1/2"	1 27/32"	1 11/16"	23/32"

Application examples

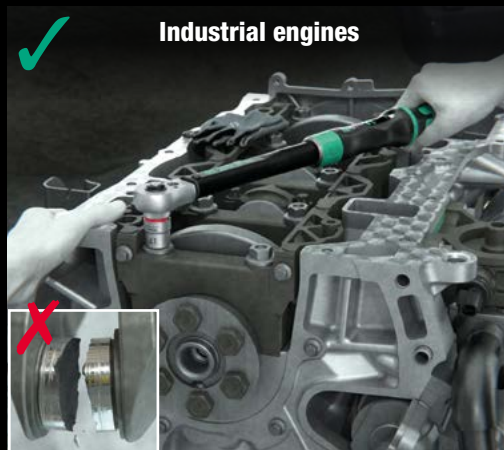

# Safe-Torque

For maximum safety thanks to a slip-over release mechanism.

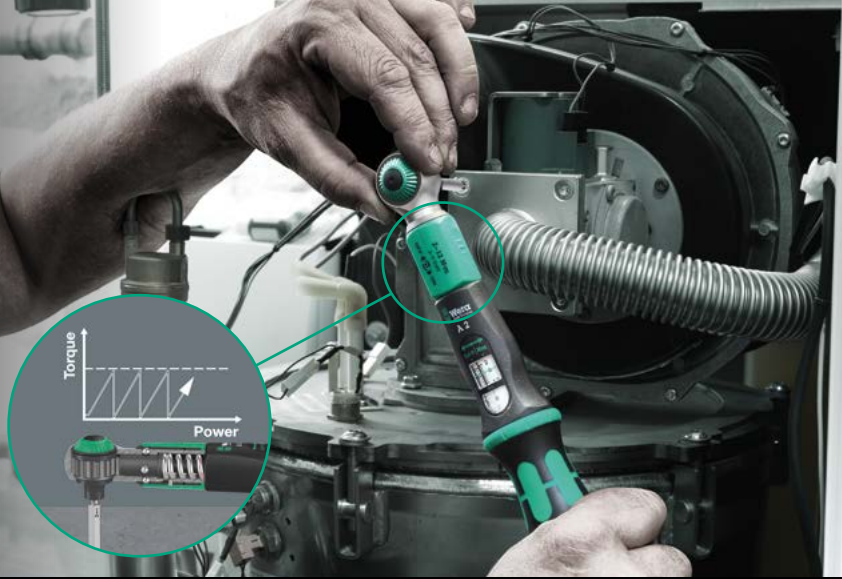

## Safe-Torque A 1 torque wrench with 1/4" square head drive, 2-12 Nm



- Slip-over mechanism: Once the set torque value is reached, the mechanism immediately slips. The torque cannot be exceeded. For clockwise/anti-clockwise tightening
- Torque function can be switched off/deactivated if required
- Measuring range: 2–12 Nm, accuracy  $\pm 10\%$

0507580001	1/4"	2-12	0,10	2-9	244	94	38,5	31,6	23,7	9 39/64"	3 45/64"	1 33/64"	1 15/64"	15/16"
------------	------	------	------	-----	-----	----	------	------	------	----------	----------	----------	----------	--------

## Safe-Torque A 1 Set 1, 1/4" square head drive, 2-12 Nm



05075830001														
○	Safe-Torque A 1	1x 1/4", 2-12 Nm												
●	8790 HMA	1x 5,5x23,0; 1x 6,0x23,0; 1x 7,0x23,0; 1x 8,0x23,0; 1x 10,0x23,0; 1x 11,0x23,0; 1x 12,0x23,0; 1x 13,0x23,0												
●	8794 SA	1x 1/4"x75,0												
	Hook and Loop Fastener Strip 240	1x 50,0x240,0												

Application examples

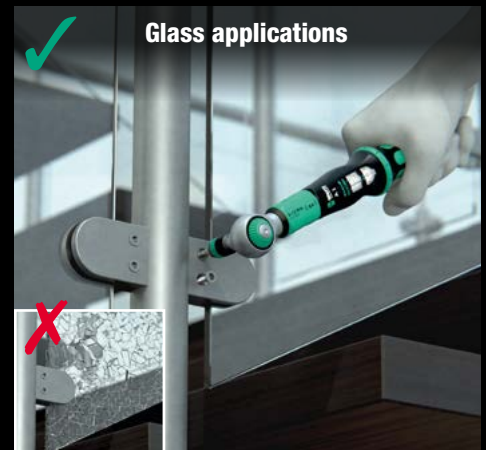
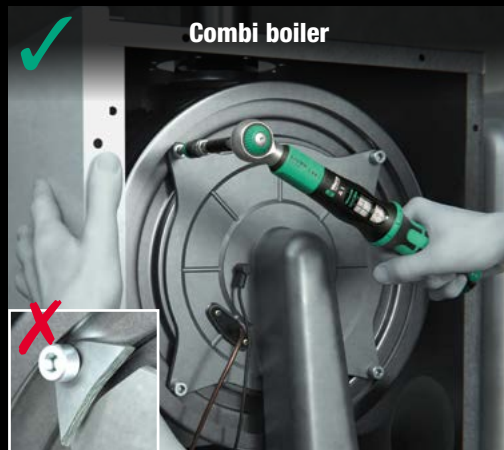

# Safe-Torque Speed

Not only safe, but also quick to adjust.



## 7515 Krafftform Safe-Torque Speed Torque screwdriver, 2-6 Nm



- Extremely fast adjustment of tightening torques via slide switch
- Slip-over mechanism: Once the set torque value is reached, the mechanism immediately slips. The torque cannot be exceeded. For clockwise/anti-clockwise tightening
- Torque function can be switched off/deactivated if required

		Nm	Nm	Nm	Nm	Nm	mm
05075815001	1/4"	2,0	3,0	4,0	5,0	6,0	147,5

## 7516 VDE Krafftform Safe-Torque Speed Torque screwdriver, 2.4-4.0 Nm



- Extremely fast adjustment of tightening torques via slide switch
- Slip-over mechanism: Once the set torque value is reached, the mechanism immediately slips. The torque cannot be exceeded. For clockwise/anti-clockwise tightening
- Torque function can be switched off/deactivated if required

	mm	Nm	Nm	Nm	Nm	Nm	mm
05075876001	9	2,4	2,8	3,2	3,6	4,0	192

Application examples

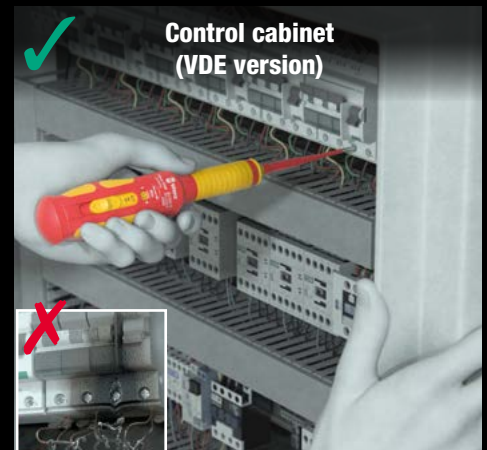
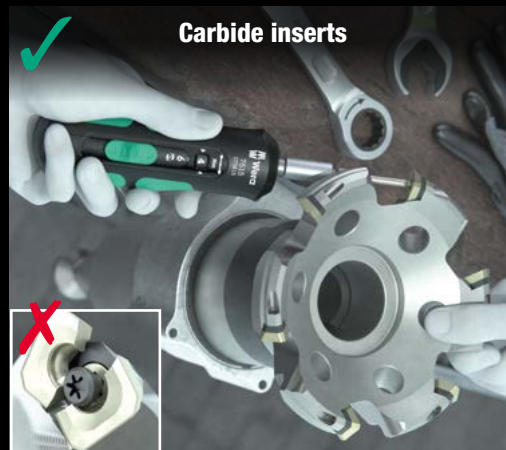



No liability for printing errors or mistakes shall be assumed.

Wera Werkzeuge GmbH  
Korzterter Straße 21-25  
D-42349 Wuppertal  
Germany  
Phone: +49 (0)202 / 4045-0  
E-Mail: [info@wera.de](mailto:info@wera.de)  
[www.wera.de](http://www.wera.de)

Wera Tools (UK) LTD.  
Railway View  
Clay Cross  
Chesterfield  
Derbyshire  
S45 9FR  
+44 (0)1246 / 277756  
[queries@wera-tools.co.uk](mailto:queries@wera-tools.co.uk)  
[weratools.co.uk](http://weratools.co.uk)

Wera Tools Inc. (North America)  
4129 Harvester Rd, Unit H  
Burlington, Ontario  
Canada, L7L 5M3  
Phone: 1-800-267-55 41  
E-Mail: [info@weratools.com](mailto:info@weratools.com)  
[www.weratools.com](http://www.weratools.com)

Wera Tools Australia Pty Ltd.  
Mike Sack  
Tel.: +61-435 755 123  
Email: [mike.sack@wera.de](mailto:mike.sack@wera.de)  
[www.wera.de/en](http://www.wera.de/en)

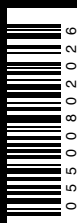

0 5 5 0 0 8 0 2 0 2 6  
EN 05 500802 026 - 20007625 - 01